

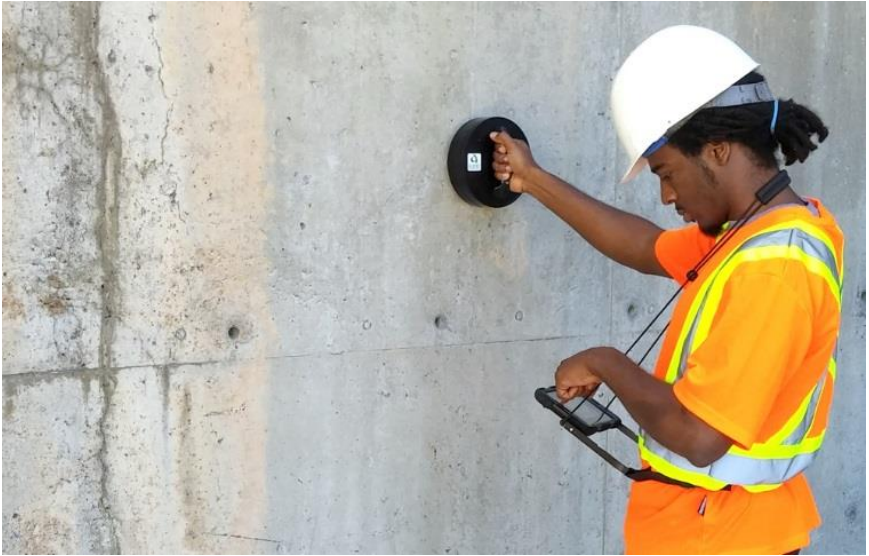

**GIATEC  
SCIENTIFIC™**

## **USER MANUAL**

---



---

# **iCOR™**

---

**CONNECTIONLESS CORROSION RATE  
MEASUREMENT DEVICE FOR  
REINFORCED CONCRETE STRUCTURES**





---

**TABLE OF CONTENTS**

---

**TABLE OF CONTENTS** ..... **I**

**PACKAGE CONTENTS** ..... **III**

**WARRANTY** ..... **V**

**SAFETY INSTRUCTIONS** ..... **1**

    SAFETY SYMBOLS ..... 1

    GENERAL GUIDELINES ..... 1

    DEVICE HANDLING ..... 2

    DEVICE OPERATION ..... 2

    DEVICE CLEANING ..... 2

    OPERATION ENVIRONMENT ..... 3

    STORAGE ENVIRONMENT ..... 3

**INTRODUCTION TO GIATEC ICOR™** ..... **4**

    CORROSION OF STEEL IN CONCRETE ..... 5

    CORROSION RATE MEASUREMENT ..... 5

    POLARIZATION RESISTANCE OF REBAR ( $R_p$ ) ..... 7

    ELECTRICAL RESISTIVITY OF CONCRETE ..... 8

    HALF-CELL POTENTIAL MEASUREMENT ..... 8

    APPLICATION ..... 9

    COMPLICATIONS/ LIMITATIONS ..... 10

**ICOR™ OVERVIEW** ..... **12**

    ICOR™ MEASUREMENT UNIT OVERVIEW ..... 12

**ICOR™ OPERATION** ..... **15**

    PREPARATION OF ELECTRODES ..... 15

    TURNING ON THE ICOR™ ..... 16

    LED INDICATOR ..... 16

CHARGING THE ICOR™ .....17

TURNING OFF AND ON THE DEVICE .....18

STORING THE DEVICE .....18

**DATA RECORDING AND PROCESSING SETUP ..... 19**

    TABLET SOFTWARE .....19

    CONTOUR PLOTS .....32

    DATA EXPORTING AND SHARING .....34

**VERIFICATION ..... 37**

    DEVICE VERIFICATION .....37

    LOG FILE .....40

**PRACTICAL CONSIDERATIONS ..... 41**

**MAINTENANCE ..... 43**

    SERVICE .....43

    REPLACEMENTS.....43

**GIATEC ICOR™ TECHNICAL SPECIFICATIONS ..... 44**

    GENERAL.....44

    OPERATING CONDITIONS.....44

**REFERENCES ..... 45**









**TERMS AND CONDITIONS OF SALE ("SALE AGREEMENT") ..... 46**

**EXHIBIT A: END USER SOFTWARE LICENSE ..... 53**

---

**PACKAGE CONTENTS**

---

Part	Qty	Photo
iCOR™ Measuring Device	1X	
Measurement Cable (for half-cell test)	1X	
Charging Cable	1X	
Charger Cable for Tablet	1X	
Contact Sponge (for half-cell electrode)	3X	
Contact Sponge (for corrosion electrodes)	12X	
Electrode Storage Solution	1X	
Conductive gel	1X	

Spray Bottle

1X



Carrying Case

1X



Data Recording App

-



Tablet with hands-free carrying support

1X



Tablet Charger

1X



Verification Kit (for half-cell potential)

1X



Verification Kit (for corrosion rate/electrical resistivity)

1X



\* Please note that the images above are for illustration purpose only and might not be to scale.

## WARRANTY

---

### LIMITED WARRANTIES

Giatic warrants the Product against defects in materials and workmanship under normal use (the “Warranty”) for a period of 12 months from the Delivery Date (the “Warranty Period”), on the condition that the Product has been completely paid for. Unless as otherwise mandated by local law, the Warranty Period does not restart if Customer receives a replacement appliance and/or replacement Software. This Warranty does not apply: (a) to consumable parts, such as batteries and cables unless damage has occurred due to a defect in materials or workmanship; (b) to cosmetic damage, including but not limited to scratches, dents and broken plastic on ports; (c) to damage caused by accident, abuse, misuse, neglect or failure to properly maintain (to include but not limited to water damage and/or condensation or improper temperatures during storage), or improper installation; (d) to damage caused by electrical disturbances or acts of God, to include but not limited to civil disturbance, war, flood, fire, rodents or insects; (e) where manufacturer’s serial numbers and security labels have been removed from the Product; and (f) to damage caused during shipment (due to Customer’s improper packaging) from Customer to Giatic in the case of Product returns for repair.

Giatic disclaims all other warranties, express or implied, including without limitation implied warranties of merchantability, fitness for a particular purpose, or against hidden or latent defects. Giatic’s responsibility for warranty claims is limited to repair or replacement. Giatic reserves the right to modify this Warranty at any time, at its sole discretion, and with notice to Customer.

Giatic does not warrant that the operation of the Product will be uninterrupted or error-free. Giatic is not responsible for damage arising from failure to follow instructions relating to the Product’s use. This Warranty is voided immediately if repair, modification (to include upgrades, expansions or usage or addition of non-manufacturer parts or accessories), alteration or other service is attempted other than by Giatic. In this regard, the integrity



of the appliance casing (aka the box) should not be violated for any reason, unless expressly authorized by Giatec in writing.

*THE WARRANTY SET FORTH IS EXCLUSIVE AND NO OTHER WARRANTY, WHETHER WRITTEN OR ORAL, IS EXPRESSED OR IMPLIED. GATEC SCIENTIFIC INC. SPECIFICALLY DISCLAIMS THE IMPLIED WARRANTIES OF MERCHANTABILITY AND FITNESS FOR A PARTICULAR PURPOSE.*

\* Please refer to the complete Terms and Conditions of Giatec's products for more details.

\* The information contained in this document is subject to change without notice.

## SAFETY INSTRUCTIONS

---

This chapter contains important safety instructions that the user must follow to operate and store the Giatec iCOR™ device. Read the following safety information before any operation to ensure your safety and to keep the device in good working condition. Keep this user manual in a safe place for future reference.

### SAFETY SYMBOLS

In order to ensure the safety of the operator and increase the service life of the instruments, pay attention to safety precautions described in this manual.

These messages are indicated by a  symbol throughout this user manual.

- WARNING:** Identifies conditions or practices that could result in injury or loss of life.
- CAUTION:** Identifies conditions or practices that could result in damage to Giatec iCOR™ or to other properties.
- ATTENTION:** Refers to the User Manual
- NOTES:** Identifies important points related to the operation of the device

### GENERAL GUIDELINES

1. Always follow basic safety precautions when using this product to reduce risk of injury from fire or electric shock.
2. Read and understand all instructions in the documentation that comes with Giatec iCOR™.
3. Observe all warnings and instructions marked on the product.

## DEVICE HANDLING



### CAUTION

---

- Giatec iCOR™ is a non-destructive testing device. The electronic parts, corrosion measurement electrodes, and half-cell potential electrode are sensitive components. Please handle them with care.
- Do not place any heavy objects on the iCOR™ device or the tablet.
- Avoid severe impact or rough handling that leads to damaging iCOR™ or the tablet.
- Do not disassemble iCOR™.
- Store the product in a protected location (e.g. carrying case) where no one can step on or trip over the connection and USB-charging cables, and in a location where these cables cannot be damaged.

## DEVICE OPERATION



### WARNING

---

- Power Input: USB only.
- Only use the provided USB charging cable for iCOR™, and the provided power adapter for the tablet.
- Do not perform measurements at the circuits directly connected to Mains (Live circuit).
- Do not place the instrument in a place where there is a chance of spilling liquids on the device.

## DEVICE CLEANING



### ATTENTION

---

- Disconnect the device from the cable after testing (in case of half-cell measurement).

- Do not use chemicals or cleaners containing harsh products such as benzene, toluene, xylene, and acetone.
- Do not submerge the iCOR™ device or the operating tablet

## OPERATION ENVIRONMENT



### ATTENTION

---

- Location: Indoor/outdoor
- Relative Humidity: 20% to 90%
- Temperature: 0°C to 45°C
- Avoid direct sunlight
- Do not submerge the device

## STORAGE ENVIRONMENT



### ATTENTION

---

- Location: Indoor
- Relative Humidity: 5% to 90%
- Temperature: 0°C to 50°C

---

## INTRODUCTION TO GIATEC iCOR™

---

Giatic iCOR™ is a compact and comprehensive non-destructive testing (NDT) device for corrosion evaluation of reinforced concrete structures. iCOR™ can be used in field applications (i.e., condition assessment) as well as laboratory testing.

iCOR™ benefits from a patented technology that makes it possible to estimate the corrosion rate of rebar through a non-invasive approach. This means that the need to connect the measuring unit to the rebar (which is the case for other commercial devices) is eliminated in iCOR™. Fig. 1 schematically illustrates the non-invasive feature of iCOR™ compared to other conventional corrosion testing devices.

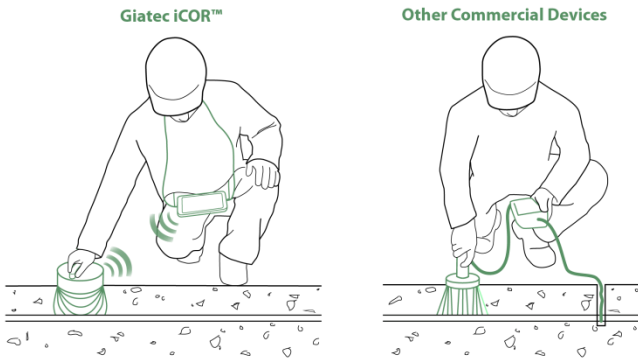
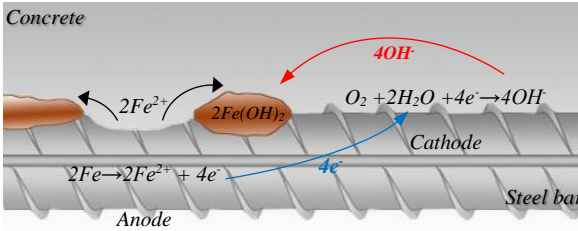

**Figure 1.** Comparison of the iCOR™ device vs other conventional devices

Giatic iCOR™ is also equipped with high precision sensors to measure the electrical resistivity of concrete, the half-cell potential, ambient temperature and relative humidity. iCOR™ benefits from a wireless capability to transmit data to a tablet, where data can be stored, analyzed and visualized. Moreover, the tablet app offers a powerful post-processing tool and an easy way to share the results with other team members. iCOR™ can significantly save time, human resources and cost.

## CORROSION OF STEEL IN CONCRETE

The corrosion of steel reinforcement inside concrete can be described as an electrochemical reaction. In this reaction, electrons migrate from the anodic zone to the cathodic zone, releasing ferrous ions at the anode and hydroxide ions at the cathode (Fig. 2). This will eventually lead to a potential difference between the anodic and cathodic areas at the surface of the steel reinforcement.

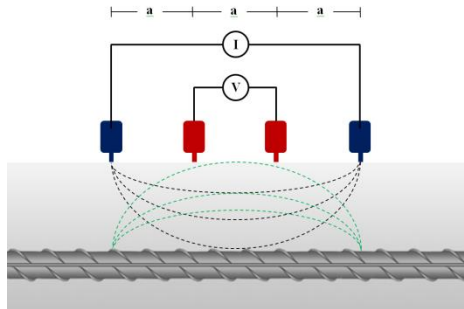

**Figure 2.** Corrosion of steel in concrete

## CORROSION RATE MEASUREMENT

### Measurement Concept

The electrical response of rebar inside the concrete can be determined from the surface of concrete with four electrodes as shown in the Fig. 3. A constant AC current is applied between the outer electrodes and the voltage between the inner electrodes is measured.



**Figure 3.** The configuration of 4 electrodes on the surface of concrete for corrosion detection of rebar inside the concrete

By sweeping the frequency of the AC current from a low frequency to a high frequency, the voltage of the system is recorded as illustrated schematically in Fig. 4.

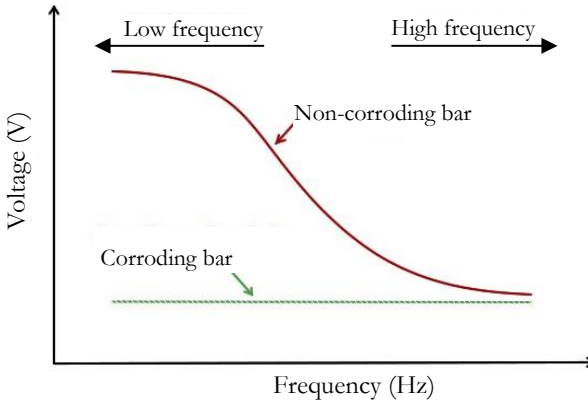

**Figure 4.** The schematic illustration of the voltage–frequency response of the corroding rebar compared to the non-corroding rebar

The voltage response of a corroding rebar is different from that of a non-corroding rebar. The voltage of a non-corroding rebar increases in the low frequency zone of the plot, but it is almost invariable for a corroding rebar. The basis of this concept has been utilized in iCOR™ technology to detect the corroding areas of reinforced concrete structures from the surface of concrete. This technology eliminates the need to have an electrical connection to the rebar inside the concrete unlike other existing non-destructive corrosion measurement techniques.

### iCOR™ Measurement Technique

As mentioned above, the low-frequency impedance response of rebar in concrete can be correlated to the corrosion state of reinforcement in concrete. However, direct measurement of the low-frequency impedance of rebar in concrete is very time-consuming and vulnerable to noise interruption; hence, it is not practical to use this technique in the field to measure the corrosion rate of rebar inside the concrete. In Giatec iCOR™, the low-frequency behavior of reinforced concrete system is determined by applying a narrow DC/AC current pulse or a DC/AC step voltage for a short

period of time and simultaneously recording the voltage of the system with a relatively high sampling rate. Using the recorded voltage and the applied current, the low-frequency impedance response of rebar in concrete can be extracted which can be used to determine the state of corrosion in reinforced concrete structures. This patented technology has been developed by Giatec Scientific Inc. and is called Connectionless Electrical Pulse Response Analysis (CEPRA).

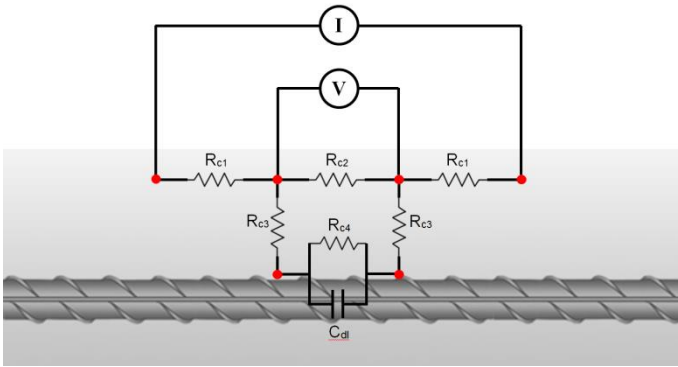

**Figure 5.** Electrical circuit of reinforced concrete system in connectionless four-electrode measurement

Giatec iCOR™ employs a complex electrical circuit model for predicting different properties of concrete materials and steel reinforcement. This electrical circuit is schematically represented in Fig 5. An advanced mathematical algorithm is implemented in the core software of the device. This core software processor is responsible for the analysis of certain characteristics of concrete materials such as the polarization resistance, electrical resistivity, and half-cell potential of embedded reinforcement.

### **POLARIZATION RESISTANCE OF REBAR ( $R_p$ )**

This parameter is related to the corrosion rate of rebar in concrete. One can calculate the corrosion rate from  $R_p$  using the following well-established equation:



$$R_p = A_p \cdot R_{c4}$$

$$i_{cor} = \frac{B}{R_p}$$

where  $A_p$  is the polarized area of rebar,  $R_{c4}$  is the charge transfer resistance of rebar defined in Fig. 5 and  $B$  is a constant parameter determined experimentally. It is important to note that the corrosion rate calculated by the CEPRA technique represents the actual corrosion rate of rebar. In other words, the  $i_{cor}$  calculated by the iCOR™ device represents the rebar mass loss divided by only the corroded area of the rebar (i.e., not the total surface area of rebar).

### ELECTRICAL RESISTIVITY OF CONCRETE

The intrinsic electrical resistivity of concrete can be calculated from  $R_{c2}$ ,  $R_{c3}$  and  $R_{c4}$  defined in Fig. 5 using the following equation:

$$\rho = 2\pi a \times R$$

where  $a$  is a constant parameter determined from the geometry of the measurement electrodes,  $R$  is the equivalent resistance of concrete calculated from  $R_{c2}$ ,  $R_{c3}$  and  $R_{c4}$ .

It is noted that the effect of rebar, unlike other concrete surface resistivity measurement techniques, would be minimized using this approach. Other AC techniques have inherent error in the measurement of concrete resistivity due to the rebar effect.

### HALF-CELL POTENTIAL MEASUREMENT

iCOR™ is also equipped with a reference electrode for half-cell corrosion measurement (Fig. 6). The purpose of the half-cell potential measurement is to determine the electrical potential on the surface of concrete which is an indication of corrosion potential of rebar in concrete.

The potential measurement is used to determine the state of rebar corrosion in concrete. This technique allows for plotting of a potential contour map on the concrete surface, which can be used to identify the corroding areas and estimate the probability of corrosion (Elsener and Bohni, 1995, ASTM C876, 2009).

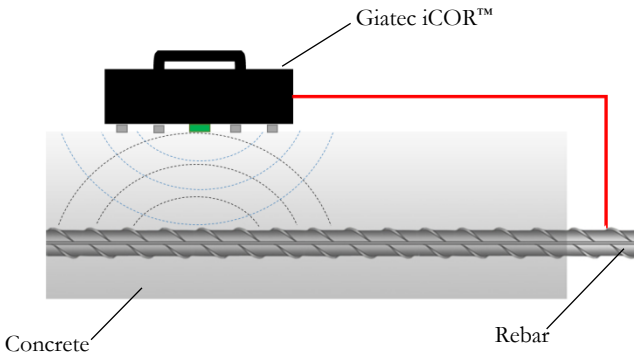

**Figure 6.** Half-cell potential measurement

**APPLICATION**

Giatec iCOR™ can be used in either field or laboratory applications to measure the corrosion rate and corrosion potential of steel reinforcement in concrete structures. This technique can be utilized for various applications such as:

- Estimation of the corrosion rate of steel reinforcement in concrete
- Measurement of corrosion potential of uncoated reinforcing steel
- Determination of corrosion activity of steel rebar

The measured corrosion potential values are indicative of corrosion probability as presented in Table 1.

**Table 1-** Relationship between the potential values and corrosion probability (adapted from ASTM C876)

Measured Potential (mV/CSE*)	Probability of Steel Corrosion Activity
> -200	Less than 10%
-200 to -350	Uncertain
< -350	More than 90%

\* CSE= Copper Sulfate Electrode

It is noted that half-cell potential measurements can also be affected by testing conditions. RILEM TC-154 (2003) reported the typical ranges for half-cell potential measurements in different conditions (see Table 2).

**Table 2-** Typical ranges of half-cell potentials of rebar in concrete (adapted from RILEM TC-154, 2003)

Condition	Potential values (mV/CSE*)	
Humid, chloride free concrete	-200	+100
Wet, chloride contaminated concrete	-600	-400
Water saturated concrete without oxygen	-1000	-900
Humid, carbonated concrete	-400	+100
Dry, carbonated concrete	0	+200
Dry concrete	0	+200

\* CSE= Copper Sulfate Electrode

## COMPLICATIONS/ LIMITATIONS

Half-cell potential measurement is a very useful technique in studying the corrosion of existing structures (or elements). However, this test does not provide any information on the kinetics of corrosion (i.e., corrosion rate of steel reinforcement). It is always recommended to interpret corrosion potential measurements with supplementary data from corrosion rate measurements as well as other tests (concrete electrical resistivity, cover thickness, and chloride profile). The presence of large cracks and delamination can affect both corrosion rate and potential data. In the case of pre-stressed post-tensioned steel tendons, these tests will not provide any useful information if the tendons are placed in protective tubes. These tests are also not applicable to concrete structures with epoxy-coated or galvanized steel rebar.

While corrosion rate and corrosion potential measurements are quite simple, the application of these techniques has several complications. For example, ambient and measurement conditions can influence these measurements. These complications can lead to misinterpretations of the collected data. The most important parameters that can influence measurements are briefly described below:

**Temperature:** The variation in ambient temperature would affect the corrosion rate, corrosion potential and concrete resistivity measurements. In a half-cell potential measurement the measured values should be corrected for the temperature effects (CEFRACOR, 2007); but temperature correction is not required for the corrosion rate measurement. It is recommended not to perform the test below freezing point.

**Moisture:** Concrete moisture has a significant effect on the corrosion rate and corrosion potential as well as the electrical resistivity of concrete. Since the moisture of concrete changes from time to time, it can affect the consistency of measurements (RILEM TC-154, 2003). The drier the concrete is, the more positive the corrosion potential, the lower the corrosion rate and the higher electrical resistivity values will be resulted performing the test.

**Cover Thickness:** The thickness of concrete cover would affect the corrosion potential as well as the electrical resistivity of concrete. A lower concrete cover leads to more negative values in half-cell potential measurements and lower values in concrete electrical resistivity of concrete. There is limited research on the effect of cover thickness on potential measurements; hence there is no straightforward correction procedure (SHRP, 2013). Therefore, it is recommended to verify the cover thickness for the area being tested in order to avoid misinterpretation of the collected data.

**Concrete Properties:** Concrete properties such as density, permeability, porosity, and electrical resistivity are factors that can affect the half-cell potential measurements. A dense concrete cover reduces the permeability of chloride and oxygen. This will reduce the oxygen concentration. As a result, the half-cell potential values tend to be more negative (Gu and Beaudoin, 1998).

**Availability of Oxygen:** The availability of oxygen at the surface of steel rebar can affect the corrosion rate and half-cell potential readings. Generally, a lower concentration of oxygen at rebar level leads to lower corrosion rate but more negative half-cell potential values (Gu and Beaudoin 1998, Elsener et al. 2003), which can be misleading.

---

## iCOR™ OVERVIEW

---

Giatec iCOR™ has two main components: iCOR™ Measurement device, and Data Recording Unit (tablet).

This section describes how to setup and operate the iCOR™ device for measuring the corrosion rate and corrosion potential of steel reinforcement in concrete structures. Before starting a test, please make sure that the iCOR™ device and your data recording unit are fully charged.

### iCOR™ MEASUREMENT UNIT OVERVIEW

Giatec iCOR™ device provides an advanced multi-test platform to measure the corrosion rate of steel reinforcement, rebar corrosion potential (Half-cell), concrete electrical resistivity, temperature and relative humidity (RH). The device is equipped with wireless technology to transmit the test data to the Data Recording Unit (Tablet) (Fig. 7).



**Figure 7.** Giatec iCOR™ Measurement Unit

Figures 8 to 10 show the components of the Giatec iCOR™ measurement device.



**Figure 8.** Giatec iCOR™ - Top view

1. Notification LED
2. ON/OFF button
3. Handle

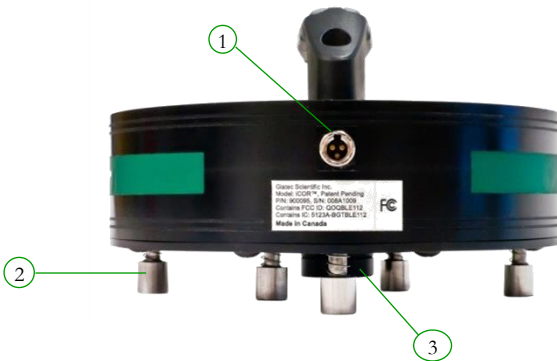

**Figure 9.** Giatec iCOR™ - Side view

1. Charging/Half-Cell connection terminal
2. Corrosion measurement electrodes
3. Half-cell potential measurement electrode

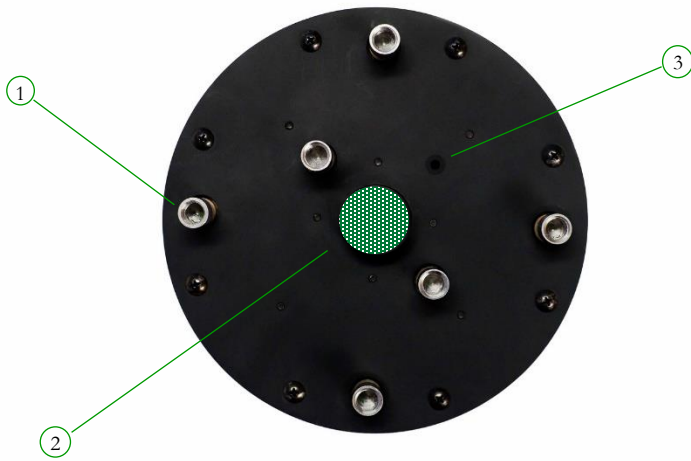

**Figure 10.** Giatec iCOR – Bottom view

1. Corrosion measurement electrodes
2. Half-cell potential measurement electrode
3. RH/ Temperature sensor inlet



#### NOTES

- There is a fixed electrochemical potential difference between the Ag/AgCl electrode (that is used in iCOR™) and the Cu/CuSO<sub>4</sub> electrode. The iCOR™ software accounts for this difference and presents the results in mV/CSE (i.e., Cu/CuSO<sub>4</sub> Electrode, CSE) as per ASTM C876.
- The reference electrode used in the measuring device has a temperature coefficient of -0.65 mV per °C for the temperature range between 0 to 50 °C. If the temperature compensation mode is selected in the Giatec iCOR™ software, the results are modified and presented for 25°C.

The Giatec iCOR™ half-cell potential measurement unit is equipped with a maintenance-free electrode. It is not required to refill or refresh the electrolyte of the electrode.

---

**iCOR™ OPERATION**

---

**PREPARATION OF ELECTRODES**

The sponge holders at the tip of corrosion measurement electrodes should be first filled with conductive gel and then the provided white sponges should be placed in the holders (Fig. 11). The cap on the half-cell potential electrode also needs to be removed and the provided green sponge should be placed in the holder when doing a corrosion potential measurement. All the sponges for corrosion measurement and half-cell electrodes should be wet before taking measurements.

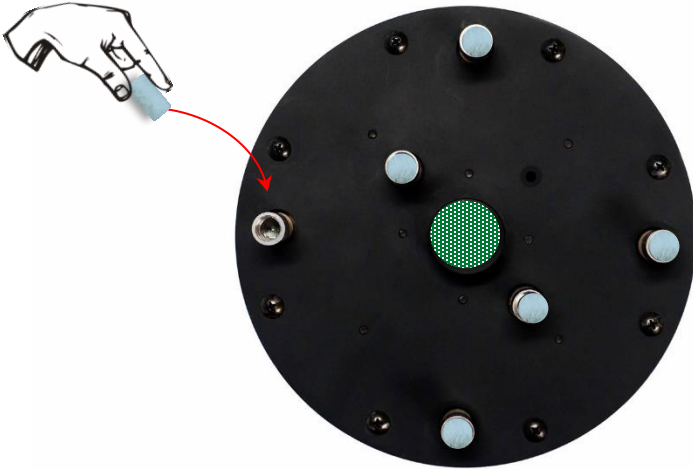

**Figure 11.** Giatec iCOR – Bottom view

 **NOTE**

---

Before performing a test, make sure that the sponges at the tip of the electrodes as well as that on the half-cell electrode are completely moist. There should not be any excess water running between the electrodes as it may cause short circuit issue during the measurements.



## TURNING ON THE iCOR™

Press and hold the main power key of the iCOR™ device for 2 seconds. This will turn on the device.

Push the button for  
2 seconds



**Figure 12.** Turning on the iCOR™

### NOTE

Do not hold the key for longer than 2 seconds, as it will turn off the device. When the device is turned on, the LED starts flashing a red color.

## LED INDICATOR

Depending on the status of the device, the LED indicator will use different colors and different flashing modes. The LED has three different modes: Continuously On, Slow Flash (Turning on every few seconds), and Fast Flash Mode. Three different colors are used to describe the status of the device: Red, Green, and Orange.

### **Continuous Mode**

The continuous mode of the LED indicator is used to represent different battery levels: When the battery level is low and the power button is pressed to turn on the device, the LED will be a red color for 5 seconds. The device will not turn on when the battery is low. A Continuous green light represents

a fully charged battery. The LED will be an orange color when the iCOR™ unit is being charged. The device will not turn on when connected to the charger.

### Slow Flashing Mode

When the LED is flashing an orange color, it represents the “advertising mode”. Advertising mode means that the iCOR™ device is turned on and the user can connect the iCOR™ device wirelessly to the Data Recording Unit (tablet). When the tablet is connected to the device, the color of the led turns green.

### Fast Flashing Mode

A flashing red LED means that the device is taking measurements. The data will be transferred to the data recording unit after the measurement is completed. Table 3 summarizes the LED indicator status in each device mode.

**Table 3.** LED color and mode for different device status

LED color	Device LED mode		
	On	Slow Flashing	Fast Flashing
<b>Red</b>	Low Battery	-	Taking Measurement
<b>Green</b>	Full Battery	Connected	-
<b>Orange</b>	Charging	Waiting to connect	-

## CHARGING THE iCOR™

The iCOR™ measurement device is powered by a rechargeable battery embedded inside the device. In order to charge the iCOR™ device, connect the charging cable to the charging socket as shown in Fig. 13. Connect the other end of charging cable (USB end) to any powered USB outlet (i.e., computer USB port, USB chargers, etc.).

Push the charging socket firmly until it clicks.



**Figure 13.** Charging Giatec iCOR™ device.

## TURNING OFF AND ON THE DEVICE

The device turns off by pressing the ON/OFF button for 5 seconds. If the device remains inactive for 5 minutes, it will automatically power off. To turn the device back ON, press and hold the ON/OFF for 2 seconds.



### NOTES

---

When the test is finished, disconnect the Bluetooth connection on the data recording unit. This can be done by either clicking on the device icon or through the main menu on the tablet app. This will help save the battery life of the device.

## STORING THE DEVICE

It is strongly recommended to turn off the device before storing the device. The sponge on the tip of the half-cell electrode should be completely wetted with the storage solution and the electrode cap should be placed and tightened on the electrode head before storing the device. This practice will significantly increase the lifetime of the electrode.

---

## DATA RECORDING AND PROCESSING SETUP

---

Data recording is performed using a fully interactive software which is pre-installed on the tablet that comes with the device. The tablet unit communicates with the iCOR™ device to receive, analyze and store the measured values. It is also capable of post-processing test data and producing colored contour plot maps for corrosion rate, concrete electrical resistivity and corrosion potential. All these operations can be easily performed by a single technician or an engineer; the results can be easily shared with other team members in real-time.

### TABLET SOFTWARE

The data recording unit for the iCOR™ device consists of a tablet with a pre-installed app. The user would have a chance to install the latest version of the iCOR™ device as soon as it becomes available online. The user will receive an online notification about the updated versions.



**Figure 14.** Welcome screen of Giatec iCOR™ software for corrosion measurement

**Step 1:** From the home screen on the tablet, tap on the “Giatec iCOR™” icon. This will launch the iCOR™ software.

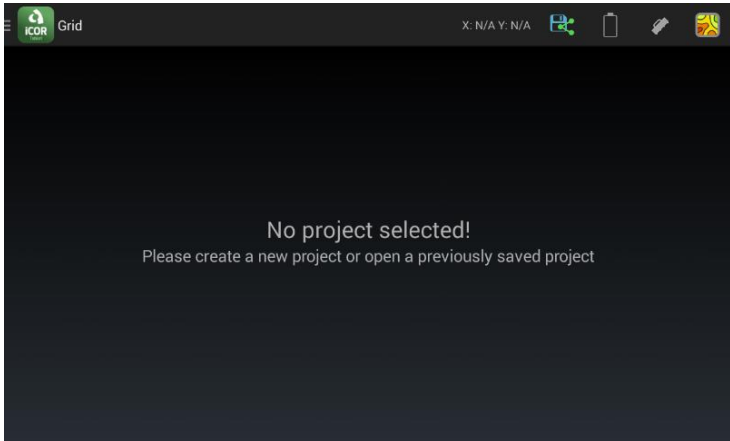



Figure 15. Launching the software

The main “Control” menu items are located at the toolbar at the top of the screen. The working area (the space designed for grid generation and data collection) is below the toolbar.

**Step 2:** On the top left corner of the screen, click on  in order to access the main menu. Click on **New** to define a new project or **Load** to open a previously saved project.

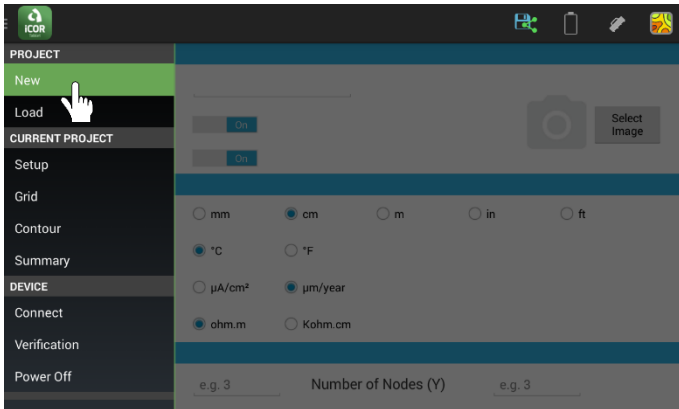
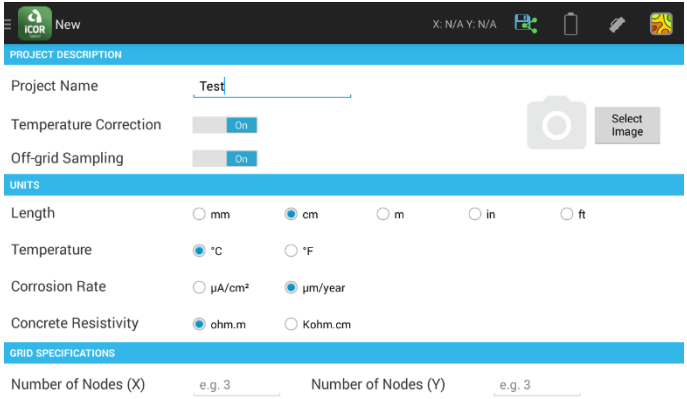

Figure 16. Start a New Project

**Step 3:** Enter the name of the project and select the temperature correction and off-grid sampling options. Define the system of units for dimensions,

temperature, and corrosion rate concrete resistivity and add the image of the project (Fig. 17a).



(a) Top section

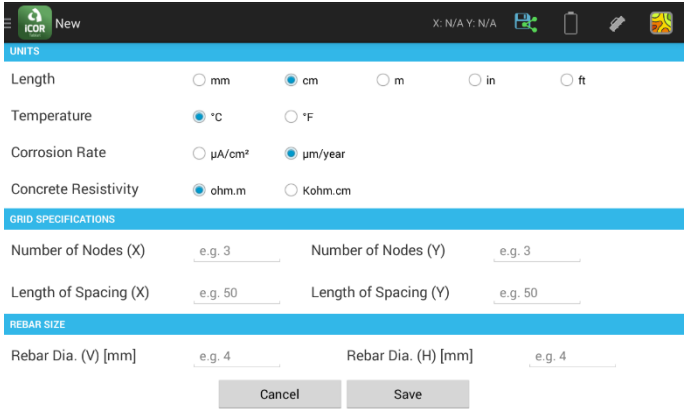

(b) Bottom section

**Figure 17.** Fill in the required information

 **NOTE**

- The software automatically corrects corrosion potential values for temperature variation. If you do not want the values to be corrected, **Turn Off** the Temperature Correction feature.
- Off-grid sampling feature enables the user to add data points which are not on the generated grid nodes. The user can select any location, and assign the measured values by double-clicking on the test grid working area screen. However, the operator can **Turn Off** the Off-grid Sampling feature.

**Step 4:** Scroll down to specify the number of nodes on the test grid in the X and Y directions and the spacing between the nodes (Fig. 17 b).

**Step 5:** Scroll down to specify the rebar diameter in both horizontal and vertical direction. Press **Save** to generate the test grid. This will generate the test grid in the working area (see Fig. 18).

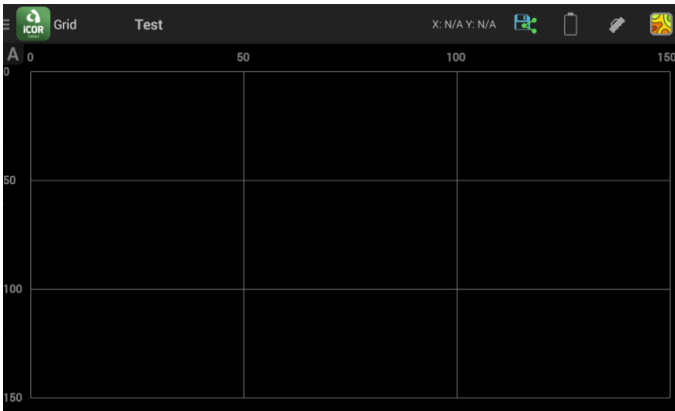

**Figure 18.** Test grid working area

**Step 6:** From the toolbar, press on **Connect** icon to connect the tablet device to the iCOR™ device (Fig 19). If the Bluetooth connectivity is off, the user will be asked to give permission to turn on the Bluetooth communication on the device.

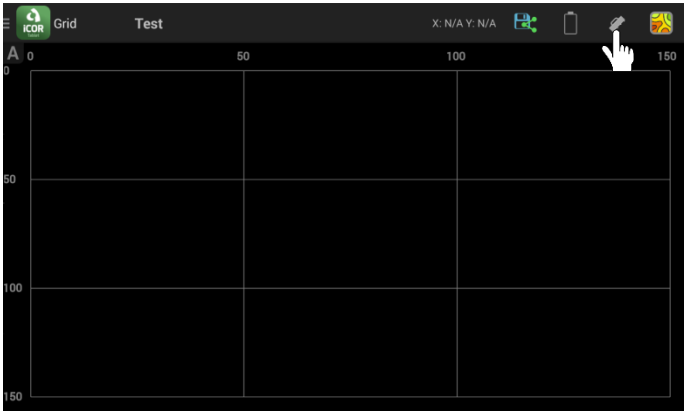

**Figure 19.** Connecting the tablet to the device

**Step 7:** A list of available device(s) will then appear on the screen. In the search results, select the iCOR™. This will connect the device to the Tablet.

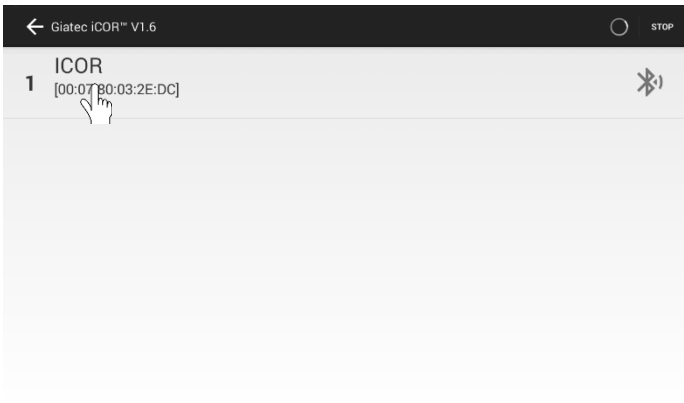

**Figure 20.** Select the appropriate device from the list



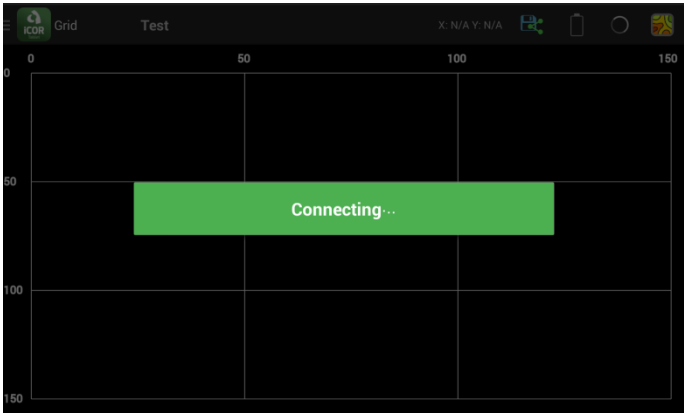

**Figure 21.** Connecting mode

When the tablet is connected to the device, the device icon on the toolbar will change to a **green** color. This indicates that the device and tablet are paired and ready for testing. The battery indicator will also turn on showing the charging level of the battery in the iCOR™ device.

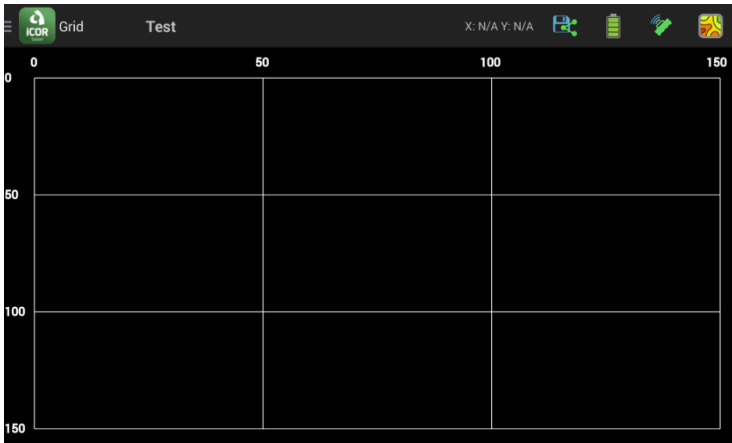

**Figure 22.** Device connected

**Step 8:** In order to conduct the measurements on a specific location on the grid, simply move the Giatec iCOR™ device to the corresponding grid point on the concrete surface (Fig. 23(a)). Press and hold the corresponding grid point on the tablet screen (Fig. 23(b)). This will direct the user to the measurement working page.

If the off-grid sampling is **Turn On**, the user can double tap anywhere on the grid to select an off-grid point where the measurement needs to be performed.

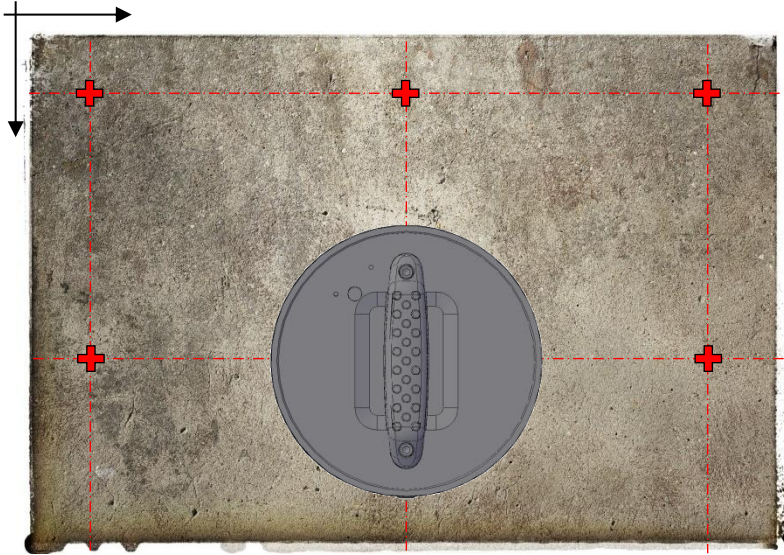

(a) Concrete surface with gridlines



(b) Press on the corresponding grid point on the tablet.

**Figure 23.** Tap on the grid point to start the measurements

**Step 9:** In this step, the user is asked to set the measurement parameters including the duration of the test, the direction of the measurement, and the concrete cover thickness over the steel bars (Fig. 24). The user can also select

which parameters to be included in the measurement. The corrosion rate measurement and concrete electrical resistivity are on by default, while the half-cell corrosion potential is off by default.

On the right side of the measurement working page, there is a space for where the test results display. After the measurement is finished, the data will be transferred to the tablet, and visualized in a chart.

After the test parameters are all set, press  to start the measurements. The commands will be transmitted to the iCOR™ device and the device will perform the test. The results will be sent to the tablet after the measurements are taken, analyzed and displayed on the tablet screen.

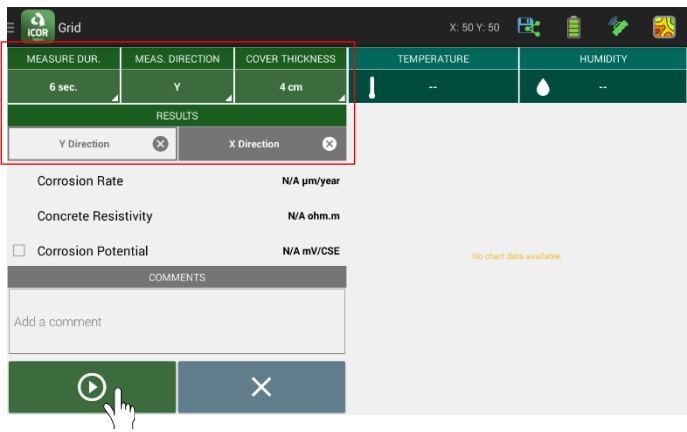

Figure 24. Test setup parameters

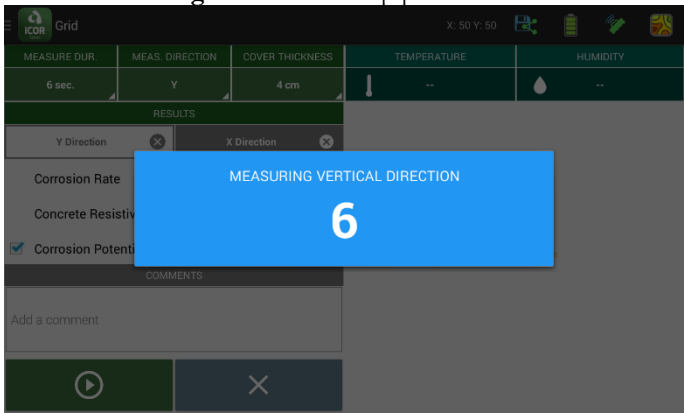

Figure 25. iCOR™ device taking the measurements

The test results will be identified with different color labels to help the user interpret the results. In Tables 4 to 6, definitions of each color codes are provided.

### Color Codes:

**Table 4** - Electrical resistivity of concrete (Langford & Broomfield 1987, Browne et al. 1983 and Millard & Gower 1992)

Color Code	Resistivity ( $\Omega.m$ )	Classification
Green	>200	Very High
Yellow	100-200	High
Orange	50-100	Moderate
Red	<50	Low

**Table 5** - Corrosion rate map

Color Code	Corrosion Rate		Classification
	( $\mu A/cm^2$ )	( $\mu m/year$ )	
Green	< 1.0	< 10	Passive/Low
Yellow	1 - 3	10 – 30	Moderate
Orange	3 - 10	30 – 100	High
Red	> 10	> 100	Severe

**Table 6** - Half-cell potential map

Color Code	Potential Value (mV/CSE)	Probability of Steel Corrosion Activity
Green	> -200	Less than 10%
Yellow	-200 to -350	Uncertain
Red	< -350	More than 90%

If there are any errors in performing the measurements, an “Error” message will appear on the screen. The user may want to repeat the test in order to verify the test condition. To do so, simply press on the redo key  to repeat the measurements. Once satisfied with the test results, the measurements can be assigned to a specific coordinate by pressing the Save key. You can discard the test results by pressing the cancel key.

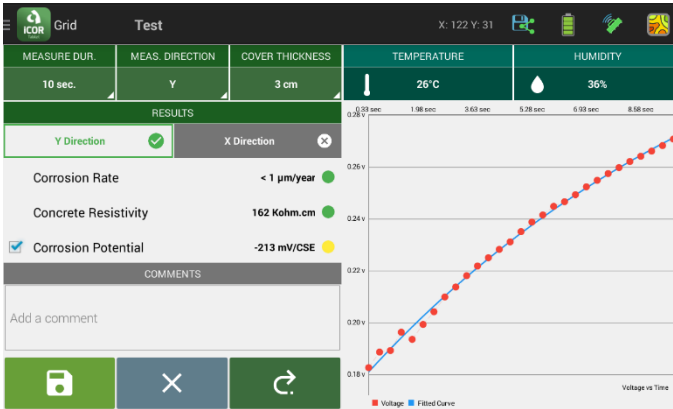
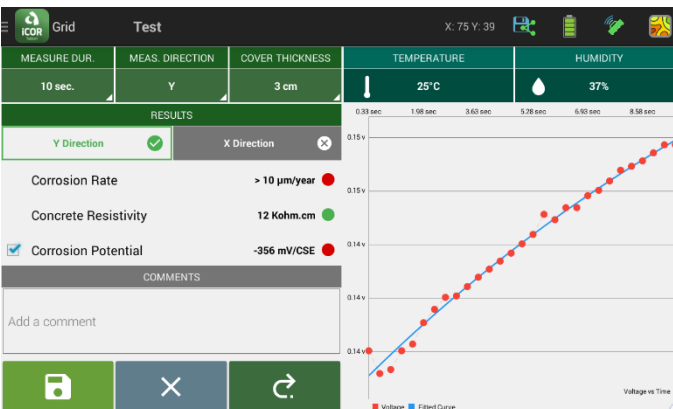
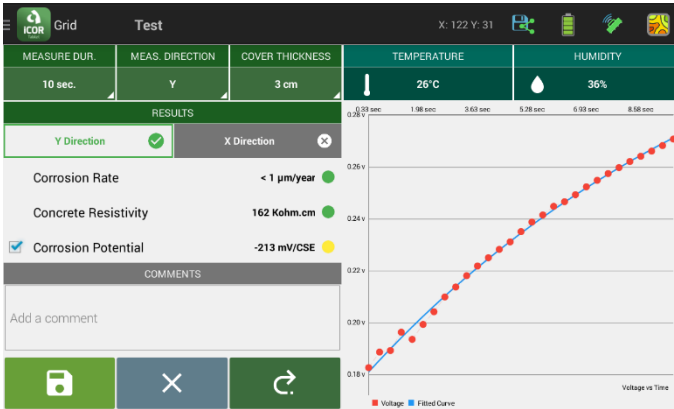

Figure 26. Results display after measurement



(a) Test sample with severe corrosion activity



(b) Test sample with low to medium corrosion activity

**Figure 27.** Analyzed data after completion of the test

There are two tabs on top of the results display area labeled as “X Direction” (horizontal) and “Y Direction” (vertical). The results will be displayed under the tab that corresponds to the measurement direction defined by the user. If **BOTH** directions are selected, the results will be displayed in both vertical and horizontal tabs and the user can switch between the two tabs to see the corresponding data by pressing the tab box (Fig. 27).

The user can also review the details of calculated variables such as the applied current, the polarization resistance of rebar ( $R_p$ ), the polarized area of rebar ( $A_p$ ) as well as the exact values of corrosion rate ( $i_{cor}$ ) and concrete resistivity ( $\rho_c$ ) by long pressing the tab boxes (Fig. 28).

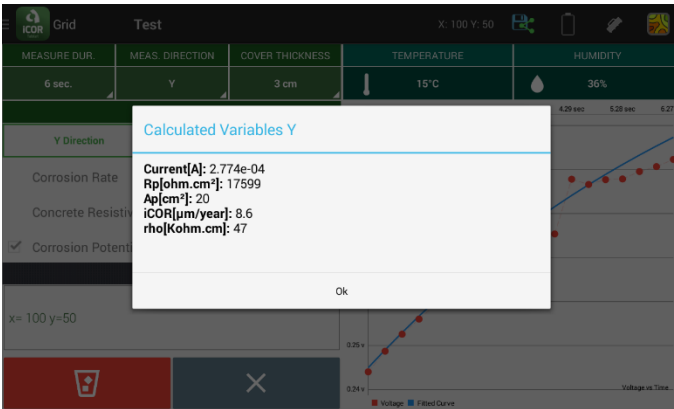

**Figure 28.** Detailed test result

The user can select to discard the test results, or redo the test. It is noted that since the measurement slightly polarizes the steel rebar, the results may be slightly different from the initial test results if the measurement is repeated immediately at the same spot.

If the measurement or the analysis of the measured data is not successful, an “ERROR” message will be displayed in a red color (Fig. 29). The user has the option to redo the measurement or discard the measurement at that particular spot.

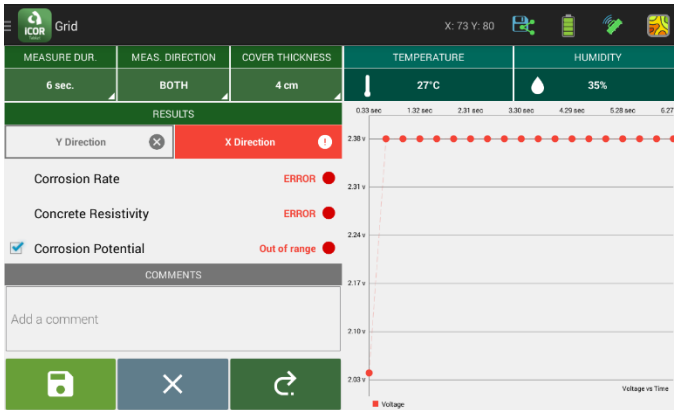

Figure 29. Error message

If the analyzed data is not within the acceptable range defined in Table 7, an “Out of Range” message will be displayed in a red color (Fig. 29). The user has the option to redo the measurement or discard the measurement at that particular spot.

Table 7- Acceptable range for the measured parameters

Parameter	Valid Range
Corrosion Rate	0.01 - 500 $\mu\text{m}/\text{year}$
Concrete Resistivity	1 – 10,000 ohm.m
Corrosion Potential	(-800) – (+200) mV/CSE

**NOTES**

- Avoid repeating the measurements on the same spot; wait about 20 to 30 min to repeat the test at the same spot.
- When one of the electrodes is located on a large piece of aggregate on the surface of concrete, the measurement cannot be done successfully. To resolve this issue, slightly change the location of the electrodes by relocating the device.
- Increase or decrease the duration of the measurement if errors persist.
- Measurement on rebar with more than a 75mm concrete cover thickness is not recommended as it may be prone to errors due to the thick layer of concrete cover on the rebar.
- Measurements are not valid on delaminated areas of concrete as the gap/crack at the interface between rebar and concrete prevents the electrical current flow into the rebar.

After finishing the corrosion rate measurements for each point, tap on “Save” to assign the test results to the selected grid point. Tested points are indicated with red bullets on the test grid working area (Fig. 30).

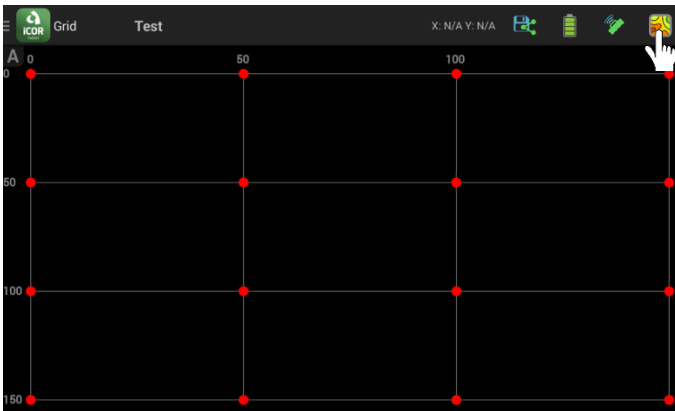

**Figure 30.** Test grid working area with measurement points



If you want to repeat the test on a previously tested location, simply press and hold the corresponding grid point. The measurement screen page will pop up showing the previously recorded data at that specific coordinate. Discard the previously saved values, and run the measurements again.

### CONTOUR PLOTS

The post-processing of the data can be done in real-time by pressing on the contour generating icon  on the top right corner of the screen. A pop-up menu will be displayed with five parameter options for contour plotting (Fig. 31). The user can select the parameter of interest for contour plotting.



**Figure 31.** Test grid working area with measurement points

The software will then analyze the data and produce a contour map for the selected parameter (Fig. 32). The user can zoom in and out and pan over the generated contour plot to review the details. The software calculates the % of total test area corresponding to the main categories specified in Tables 4-6 of this manual. This information is displayed at the toolbar at the top of the screen.

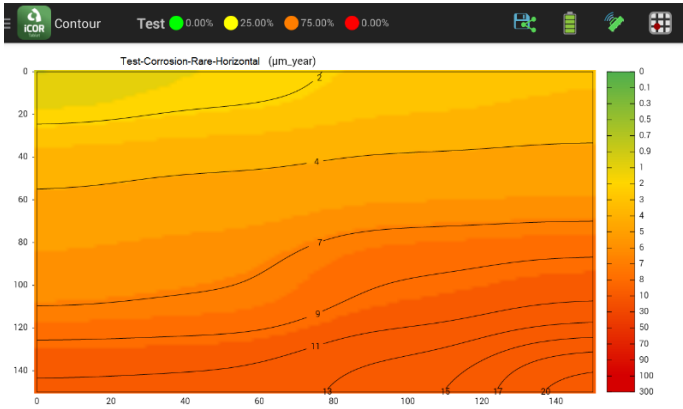
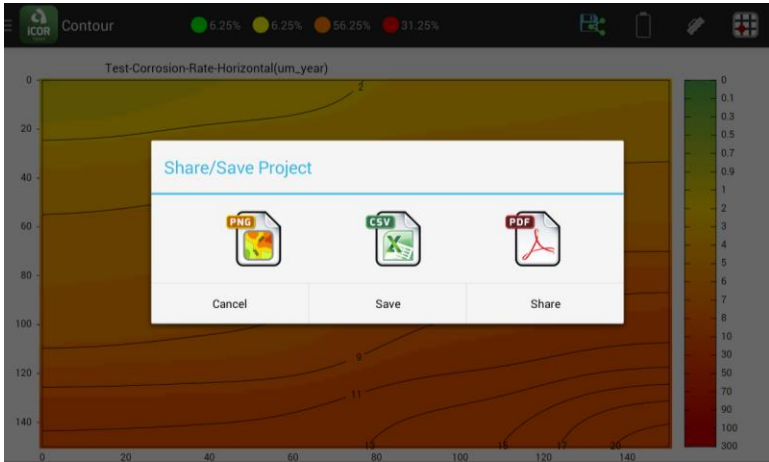

Figure 32. Corrosion rate Y Direction (Vertical) contour map

## DATA EXPORTING AND SHARING

By clicking on the share icon at the top of the screen, the data can be exported and shared in a spreadsheet format (CSV), image format (PNG), and PDF format.

To save the project, select the appropriate file format and press on the **Save** button. A dialog box will appear asking to define a location for the file. Enter a location where you want to save the file and click **OK**.



(a) Select the output file format

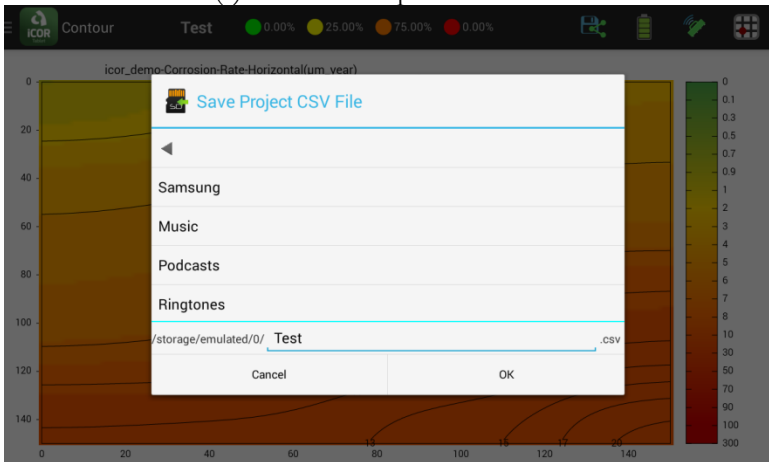

(b) Select the file destination

Figure 33. Save Project

To share the data, select the appropriate file format and press **Share** button. A dialog box will appear asking to select a share method, such as email, cloud storage (Google Drive, Dropbox, etc.) or through Bluetooth communication.

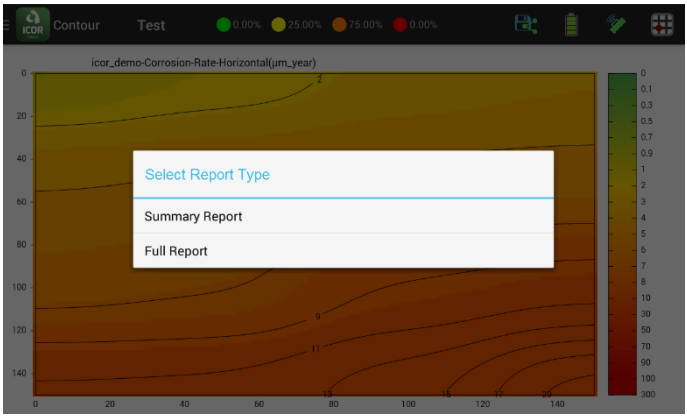

(a) Select the report type

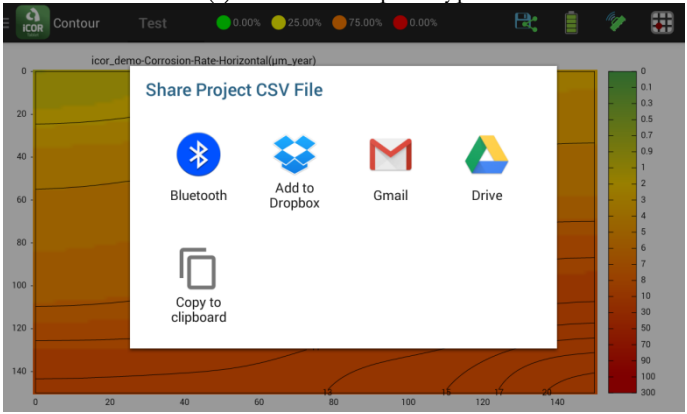

(b) Select the sharing method

**Figure 34.** Sharing project output

Note: The user can only save in the PNG and PDF format if a contour map was generated. However, it is possible to save the raw data in a CSV format without generating the contour map. This can be achieved by selecting the share icon at the top of the screen and selecting the CSV Share or Save option. Fig. 35 shows a typical PDF report format generated by the software.

DESCRIPTION

Project Name:	Test
Date Created:	January 01, 2014 7:59 AM
Corrosion Rate Unit:	µm/year
Length Unit:	cm
Temperature Unit:	°C
Temperature Correction:	On
Number of Nodes (X):	4
Node Spacing (X):	50
Number of Nodes (Y):	4
Node Spacing (Y):	50



SUMMARY

Measurement Range	Area(%)
> 10	56.25
3 to 10	18.75
1 to 3	25.0
< 1	0.0

CORROSION RATE VERTICAL CONTOUR MAP

(a) Project Description in the PDF report

CORROSION RATE VERTICAL CONTOUR MAP

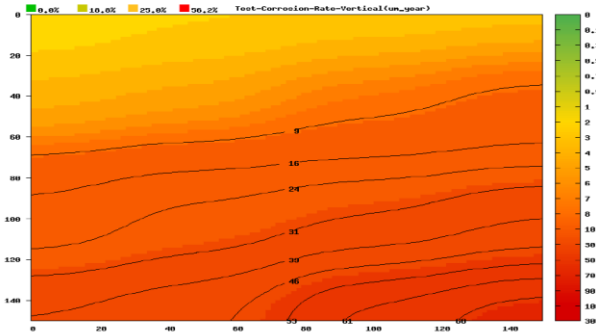

signature

Report Generated by Giatec iCOR™

Tabulated file in CSV format is enclosed

(b) Contour Map in the PDF report

CORROSION RATE VERTICAL TEST RESULTS - RAW DATA

X	Y	Corrosion Rate (µm/year)	Temperature (°C)	RH	Duration (sec)	Cover (cm)
0	0	2.145	15.5	33%	6	3
50	0	2.781	13.5	36%	6	3
100	0	2.9833	10.5	42%	6	3
150	0	3.2216	17.5	33%	6	3
0	50	4.623	16.0	33%	6	3
50	50	5.471	18.0	31%	6	3
100	50	8.452	15.0	36%	6	3
150	50	11.564	16.0	44%	6	3
0	100	18.86	15.0	36%	6	3
50	100	26.683	12.0	41%	6	3
100	100	32.013	13.0	36%	6	3
150	100	38.941	11.0	41%	6	3
0	150	40.467	12.0	39%	6	3
50	150	44.978	16.0	34%	6	3
100	150	65.71	17.0	32%	6	3
150	150	76.052	12.0	39%	6	3

(c) Raw Data in the PDF report

Figure 35. Typical PDF Report in iCOR™ app

---

## VERIFICATION

---

### DEVICE VERIFICATION

It is strongly recommended to verify the accuracy of the measuring device prior to any field or laboratory test using the verification kits. Two verification kits are provided; one for the half-cell corrosion potential measurement and another one for both the corrosion rate and electrical resistivity.

**Step 1-** Connect the tablet to the iCOR™ (refer to the instruction on page 22, Step 6)

**Step 2-** Access the Verification through the Main Menu.

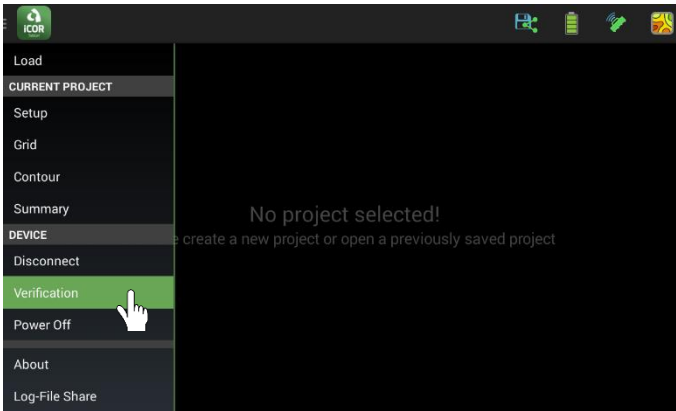

**Figure 36.** Verification option in the menu

**Step 3-** In this step a menu will pop-up asking the user which measurement verification needs to be performed. The user can choose between Half-cell Potential and Corrosion Rate/Concrete Resistivity.

#### **Step 4(a)-** Half-cell Potential Verification

The half-cell verification kit consists of a very accurate reference electrode (i.e., red probe).

Open the cap of the red verification electrode and the half-cell potential measurement electrode. Make sure that the green contact sponge is wet.

Remove the sponge inside the verification electrode and make sure the white surface inside the verification probe is moist.

Twist the verification kit on top of the half-cell measurement electrode, then connect the cable from the half-cell connection terminal to the end of the verification electrode (i.e., red probe) by pushing the banana jack into the socket (Fig.36). Make sure there is a good contact between the sponge and the verification electrode.

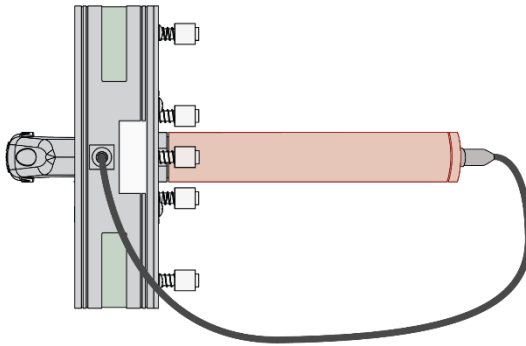
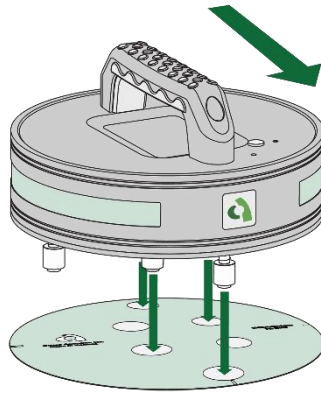

**Figure 37.** Half-cell potential verification

**Step 4 (b)-** Corrosion Rate/ Concrete resistivity Verification procedure

To perform the verification of the Corrosion Rate/Concrete Resistivity **no sponges** should be placed on the electrodes.

Verification can be performed on both Y (vertical) and X (horizontal) direction. The Y direction by default is the direction parallel to the handle (see Fig. 40). Make sure the measuring electrodes are properly placed on the verification kit; the electrodes should be in full contact with the circles on the verification kit (Fig.38).



(a) Vertical verification

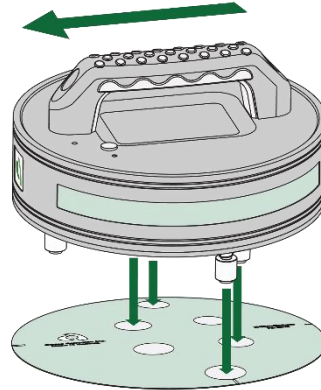

(b) Horizontal verification

**Figure 38.** Corrosion rate/ concrete resistivity verification

**Step 5-** Press  to start the verification process. The application will take six seconds to perform the test. The results will be display as a “PASS” or “FAIL” message. If the verification fails, please contact our technical support team using the information on the back of this user manual



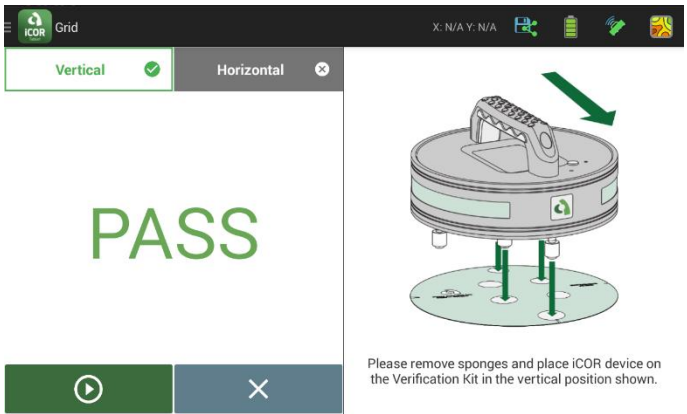

(a) Pass message after verification

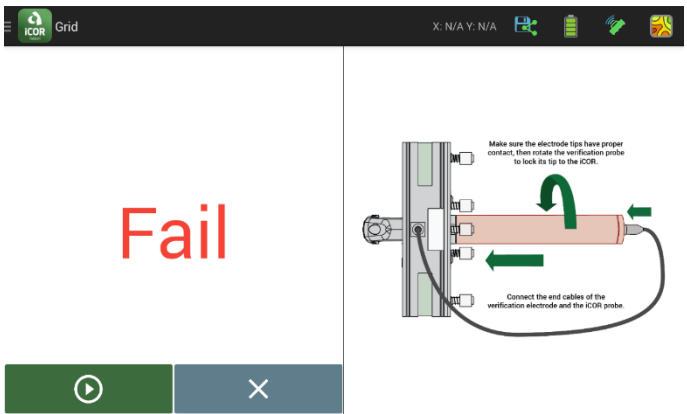

(b) Fail message after verification

**Figure 39.** Verification status

## LOG FILE

In case of technical assistance or troubleshooting related to measurement difficulties or data interpretation, our technical support team may ask the user to share the Log-File of the project in encrypted format using the option located at the bottom of the main menu.

---

## PRACTICAL CONSIDERATIONS

---

This section provides general recommendations for a successful evaluation of corrosion in reinforced concrete structures.

**Charging the iCOR™ Device and Data Recording Unit:** It is strongly recommended to fully charge the iCOR™ device and data recording unit (tablet) before conducting measurements in the field. Refer to the iCOR Operation Section of this user manual to learn how to charge the device.

**Electrodes positioning:** The location of the corrosion measurement electrodes affects the measurement of corrosion rate. The electrodes should be placed on the surface of concrete in parallel to the direction of rebar in concrete. They should be placed on top of the rebar (not more than 25 mm away from the rebar) in the direction of the measurement (See Fig. 40). For instance, if the user wants to measure the corrosion rate of rebar in the Y-direction (vertical), the two electrodes of the device in Y-direction (vertical) should be placed on top of rebar in the same direction.

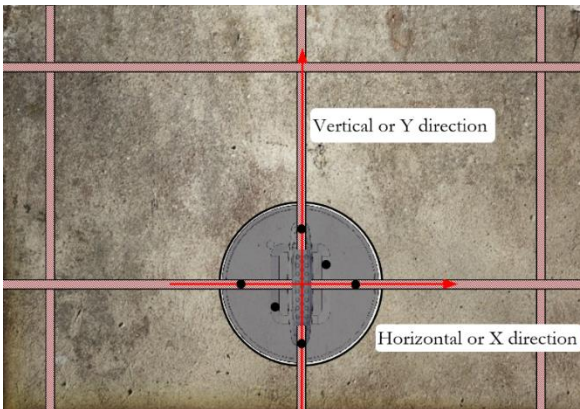

**Figure 40.** Electrodes positioning with respect to the location of rebar

**Testing Grid:** In order to facilitate the corrosion measurement, it is recommended to mark a test grid on the surface of the concrete. The grid lines need to be in alignment with the locations of rebar in both horizontal and vertical directions. The user is encouraged to perform the test in a systematic order to efficiently keep track of recordings.

**Pre-moistening the surface:** If the surface of concrete element is too dry, there is a chance this will affect the measurements. In order to avoid this problem, it is recommended to moisten the surface of the concrete element approximately 15-20 minutes before performing the readings. However, there should not be any excess water on the surface during the test.

**Consider the effect of coatings:** The presence of isolating coatings (i.e., organic coating, sealing epoxy, asphalt layer) on the surface of concrete and/or on the rebar will make it impossible to perform measurements unless it is completely removed (Ramniceanu 2004, Geenen F.M 1991). However, there are some cement-based coatings that are generally applied on the surface of concrete for an aesthetic purpose; if the electrical resistivity of these coating types is in the range of concrete electrical resistivity, it will be possible to obtain valid data.

## MAINTENANCE

---

Repairs and servicing are not covered in this user manual and should only be performed by qualified personnel.

Periodically wipe the device with a damp cloth. Do not use abrasives or solvents.

The sponges on the tip of the half-cell electrode should be completely wetted with the storage solution and the electrode cap should be placed and tightened on the electrode head before storing the device. This practice will significantly increase the lifetime of the electrode. This practice should also be applied to the half-cell verification electrode.

## SERVICE

If the iCOR™ device does not turn on, check the LED on the device for the battery status and charge the device if required. If iCOR™ still does not work properly; review this user manual to make sure you are operating it correctly.

If iCOR™ malfunctions, call our technical support number provided on the back of this manual. After consulting with our technical support department if a return is required, the instructions for packaging and returning the device will be provided.

## REPLACEMENTS

For Giatec iCOR™, use only the replacement part specified. The USB cable is intended to be used only by the iCOR™ device and connecting it to other instruments might damage the cable. Please contact Giatec Scientific Inc. for further assistance.

---

**GIATEC iCOR™ TECHNICAL SPECIFICATIONS**

---

**GENERAL**

Type	Electrical resistance electrode	Half-cell electrode	Temperature sensor	RH sensor
Measurement Range	0 ~ 3 kΩ	- 1 ~ +1 V	-10 ~ 75 °C	0 ~ 100%
Measurement Accuracy	±(10Ω +2%)	±10 mV	±1 °C	±3 %
Sampling Rate	3 samples per second			
Communication Protocol	Bluetooth 4 LE			
Temperature and Humidity Response Time	30 min			
Communication range	Up to 10 meter			
Data transfer rate	Less than 1s			

**OPERATING CONDITIONS**

Type	Value
Operating temperature	0 ~ 45 °C
Operating humidity	20 ~ 90%
Storage temperature	0 ~ 50°C
Storage humidity	5 ~ 95%
Weight of iCOR™ Device	800 gr
Dimensions of iCOR™ Device	184 mm x 116.5 mm (D x H)

---

**REFERENCES**

---

- [1] Elsener, B., and Böhni, H. (1995). Condition evaluation of reinforced concrete bridges—The benefits of potential mapping. Proc. 6th Int. conf. Structural Faults Repair, London, 47-52.
- [2] ASTM C876. 09. Standard test method for half-cell potentials of uncoated reinforcing steel in concrete, Annual Book of ASTM Standards.
- [3] RILEM TC 154-EMC. 2003. Half-cell potential measurements- Potential mapping on reinforced, Concrete Structures, Materials and Structures. 36, 461-471.
- [4] CEFRA COR (2007). Recommendations for the verification of reference electrodes-PCRA 005. Committee for Cathodic Protection and Associated Coatings.
- [5] Strategic Highway Research Program (SHRP) (2013). Non-destructive Testing to Identify Concrete Bridge Deck Deterioration, Transportation Research Board, Washington D.C.
- [6] Gu, P. and Beaudoin, J.J. 1998. Obtaining effective half-cell potential measurement in reinforced concrete structure, Institute for research in construction, NRC, 1-4.
- [7] Elsener, B., Andrade, C., Gulikers, J., Polder, R., & Raupach, M. (2003). Half-cell potential measurements—Potential mapping on reinforced concrete structures. Materials and Structures, 36(7), 461-471.
- [8] Langford, P., & Broomfield, J. P. (1987). Monitoring the corrosion of reinforcing steel. Construction Repair, 1(2), 32-36.
- [9] Browne, R. D., Geoghegan, M. P., & Baker, A. F. (1983). Analysis of Structural Condition from Durability Results. Corrosion of Reinforcement in Concrete Construction. Chichester: Ellis Horwood, , 193-222.
- [10] Millard, S. G., & Gowers, K. R. (1992). Resistivity assessment of in-situ concrete: the influence of conductive and resistive surface layers. Structures and Buildings, 94(4), 389-396.

---

## TERMS AND CONDITIONS OF SALE ("SALE AGREEMENT")

---

Please read this Sale Agreement before using the Giatec Scientific Inc. ("Giatec") product (the "Product"). By finalizing Your purchase order, You, the purchaser of the Product, and, if applicable, any end user ("End User") on whose behalf You are making this purchase for (You and the End User are hereafter collectively referred to as "Customer"; Customer and Giatec are hereafter together referred to as "Parties") agree to be bound by and accept the terms and conditions provided below. If You and/or the End User, as the case may be, disagree with these terms and conditions, do not finalize Your order, or if the order has been placed, return the Product immediately upon receipt without using it.

**Payment; Purchase Price and Associated Charges.** Payment must be made at the time of order unless otherwise agreed to by the Parties. Customer will pay the total purchase price plus shipping and handling, if any, as specified on the emailed invoice. Customer is also responsible for all taxes related to this purchase and to the import of the Product, if applicable, to include but not limited to all sales taxes, value-added taxes, import taxes/customs/duties, and any other similar taxes imposed by any governmental entity.

**Title; Risk of Loss.** Title to the Product passes to Customer when the Product is paid for in full. However, Giatec bears all responsibility for loss of or damage to the Product during initial shipment after purchase and until Product is received by Customer, unless Customer selects its own mode of shipping. In repair cases, risk of loss is borne by Customer for return of the Product, but by Giatec following repair and upon return to Customer.

**Limited Warranties.** Giatec warrants the Product against defects in materials and workmanship under normal use (the "Warranty") for a period of 12 months (#) from the Delivery Date (the "Warranty Period"), on the condition that the Product has been completely paid for. Unless as otherwise mandated by local law, the Warranty Period does not restart if Customer receives a replacement appliance and/or replacement Software. This

Warranty does not apply: (a) to consumable parts, such as batteries, Plexiglas cell units and cables unless damage has occurred due to a defect in materials or workmanship; (b) to cosmetic damage, including but not limited to scratches, dents and broken plastic on ports; (c) to damage caused by accident, abuse, misuse, neglect or failure to properly maintain (to include but not limited to water damage and/or condensation or improper temperatures during storage), or improper installation; (d) to damage caused by electrical disturbances or acts of God, to include but not limited to civil disturbance, war, flood, fire, rodents or insects; (e) where manufacturer's serial numbers and security labels have been removed from the Product; and (f) to damage caused during shipment (due to Customer's improper packaging) from Customer to Giatec in the case of Product returns for repair.

Giatec disclaims all other warranties, express or implied, including without limitation implied warranties of merchantability, fitness for a particular purpose, or against hidden or latent defects. Giatec's responsibility for warranty claims is limited to repair or replacement. Giatec reserves the right to modify this Warranty at any time, at its sole discretion, and with notice to Customer.

Giatec does not warrant that the operation of the Product will be uninterrupted or error-free. Giatec is not responsible for damage arising from failure to follow instructions relating to the Product's use. This Warranty is voided immediately if repair, modification (to include upgrades, expansions or usage or addition of non-manufacturer parts or accessories), alteration or other service is attempted other than by Giatec. In this regard, the integrity of the appliance casing (aka the box) should not be violated for any reason, unless expressly authorized by Giatec in writing.

**Technical Support.** Giatec will provide technical support to Customer in accordance with the then-current support policy in effect and in accordance with the Warranty provided herein, unless full payment for the purchase of the Product is not received. Giatec will respond to Customer support problems by phone or by email inquiry. If a support problem cannot be rectified via phone or email, Customer will be provided with return instructions.



Customer agrees and understands that it may be necessary for Giatec to collect, process, and use Customer data to perform the support and repair obligations identified herein. This may include the necessity to transfer data to affiliate third parties that are contracted with Giatec to assist in meeting these obligations. In doing so, Giatec will (i) protect and keep confidential such information, (ii) not use such information for reasons other those discussed above, and (iii) not sell, distribute or pass on such information to any third party.

**Repair.** Customer should carefully inspect the Product upon its delivery. Customer should maintain all original packaging upon receiving the Product until the Product has been installed and is found to be in proper working order.

If the Product arrives to Customer (the date of arrival is referred to herein as the “Delivery Date”) damaged or defective at initial delivery, Customer must notify Giatec Technical Support within 30 days from the Delivery Date of the condition of the Product and obtain return instructions if needed. Product must then be returned immediately to Giatec for repair or replacement at Giatec’s discretion. Giatec will then arrange for delivery of temporary or permanent replacement Product. Customer is responsible for properly packing the return shipment of the Product. Giatec will arrange for shipping and insurance.

If Customer fails to notify Giatec within 30 days of the Delivery Date, (i) the Refund Policy below will not apply, (ii) Customer will bear the cost of returning the Product for repair, and (iii) damaged Product will not be accepted.

If during the Warranty Period (as described herein) but following the initial 30 day period the Product is not working properly, Customer must contact Giatec Technical Support to confirm the problem and obtain return instructions if needed. Customer will pay shipping and insurance costs when returning the Product for repair.

If the Product is returned for repair or replacement at any time following purchase by Customer and Giatec discovers that the Warranty is inapplicable due to the reasons provided above (see the “Limited Warranties” section hereof), the Product will not be repaired and will be returned to Customer at

Customer's expense, unless Customer authorizes and pays for repair. Whether Customer authorizes repair or not, Giatec reserves the right to charge a "No Fault Found" fee where the Product is found not to be defective due to any fault of Giatec.

Any Giatec reseller or distributor involved in the purchase of the Product is not authorized to make any modification, extension, or addition to the Limited Warranties provided by Giatec herein, although any such reseller or distributor may provide its own warranty in addition to the warranty coverage provided by Giatec.

**Refund Policy and Product Return.** On a case-by-case basis, Giatec reserves the right to authorize a full refund of any Product purchase made where a refund is requested within 30 days of the Delivery Date. In such cases where a refund is approved, End User will return the Product to Giatec if the End User made such order itself. If the Product was ordered by a distributor or reseller, such distributor or reseller will coordinate with Giatec for the return of the Product. In either case, Customer is responsible for shipping and insurance charges and any damage to the Product which takes place en route to Giatec. Giatec reserves the right to charge a nominal restock fee for any such returns.

**Limitation of Liability.** Giatec is not liable under any other agreement between End User and a Giatec reseller or distributor for the provision of support (to include but not limited to an extended warranty or any support, service or repair agreement).

If found to have breached this Sale Agreement, Giatec is not liable for any amount above the aggregate dollar amount paid by Customer for the purchase of the Product under this Sale Agreement. Except as provided in the Warranty and to the extent permitted by law, Giatec is not responsible for indirect, special, incidental or consequential damages resulting from any breach of this Sale Agreement, including but not limited to loss of use; loss of revenue; loss of actual or anticipated profits (including loss of profits on contracts); loss of the use of money; loss of anticipated savings; loss of business; loss of opportunity; loss of goodwill; loss of reputation; loss of, damage to or corruption of data or software programs; or any indirect or consequential loss or damage howsoever caused including the replacement

of equipment and property, any costs of recovering, programming, or reproducing any program or data stored or used with the Product and any failure to maintain the confidentiality of data stored on the product. The foregoing limitation shall not apply to death or personal injury claims, or any statutory liability for intentional and gross negligent acts and/or omissions.

**Not For Resale.** The Product may not be purchased for resale purposes by Customer unless Customer is a legal and authorized reseller of Giatec products.

**High Risk Uses.** Customer will not purchase the Product for usage in connection with any high risk or strict liability activity (including, without limitation, air travel, space travel, firefighting, police operations, vehicle operations, power plant operations or power generation applications, transport management systems, military operations, rescue operations, hospital and medical operations or the like) whereby such usage could cause or contribute to damage to property or injury to persons.

**Software License.** The Product is and contains, the intellectual property of Giatec, and is protected by Canadian, U.S. and international copyright, patent, trade secret laws and international treaties. This Agreement is not intended to grant, and shall in no way be construed to grant, to Customer any rights in the intellectual property of Giatec, including the intellectual property in the Products. The Customer shall obtain a non-exclusive license to use the software contained in the Product (the “Software”) only in accordance with the terms of the Software License Agreement, attached hereto as Exhibit A, and the Customer shall agree with its terms prior to installing the Software. Customer acknowledges that the Software is the intellectual property of Giatec and respects Giatec’s rights as the intellectual property rights holder. Customer may not and customer agrees not to, or to enable others to, copy, decompile, reverse engineer, disassemble, attempt to derive the source code of, decrypt, modify, or create derivative works of the Software or any part thereof (except as and only to the extent any foregoing restriction is prohibited by applicable law). Any attempt to do so is a violation of the rights of Giatec. By virtue of this Sale Agreement, Customer acquires only the right to use the Software as contained in the Product and does not acquire any

rights of ownership. All rights, title and interest in the Software shall at times remain the property of Giatec.

**Product Disposal/Recycling.** Giatec is unable to dispose of or recycle the Product following use. End User may dispose of or recycle the Product or arrange for the same through the Giatec distributor or reseller which made the Product sale. Any disposal or recycling of the Product must be done in accordance with local government directives.

**Export.** Customer must comply with all export laws and restrictions and regulations of Canada. Furthermore, Customer will not export, or allow the export or re-export of the Product in violation of any such restrictions, laws or regulations. Additionally, Customer agrees to comply with the above and represents and warrants that it is not located in, under the control of, or a resident of any restricted country.

**Entire Agreement.** This Sale Agreement constitutes the entire understanding of the Parties as to the subject matter hereof and supersedes all prior offers, agreements, arrangements, negotiations and understanding, written or oral between the parties relating to that subject matter.

**Severability; Assignment.** If any provision of this Sale Agreement is held to be unenforceable for any reason, the legality or enforceability of the remaining terms shall not be affected or impaired. The failure of Giatec to act with respect to a breach of this Sale Agreement by Customer or others does not constitute a waiver and shall not limit Giatec's rights with respect to such breach or any subsequent breaches. Giatec expressly reserves the right to assign this Sale Agreement and to delegate any of its obligations hereunder. Customer may not assign, delegate or otherwise transfer (whether by operation of law or otherwise) this Sale Agreement or any of Customer rights or obligations hereunder without the prior written consent of Giatec. Giatec may assign the provision of repair services to third parties.

**Governing Law; Dispute Resolution.** All disputes arising out of or in connection with this Sale Agreement shall be finally settled under the Rules of Arbitration of the International Chamber of Commerce by one or more arbitrators appointed in accordance with the said Rules. The place of arbitration shall be Ottawa, Ontario, Canada. The language of the arbitration shall be English. For the purposes of this arbitration, this Sale Agreement

shall be governed by and construed under Ontario law as such law applies to agreements between Ontario residents entered into and to be performed within Ontario, Canada. The decision of the arbitrators shall be binding upon the parties hereto, and the expense of the arbitration (including without limitation the award of attorneys' fees to the prevailing party) shall be paid as the arbitrators determine. The decision of the arbitrators shall be executory, and judgment thereon may be entered by any court of competent jurisdiction.

Any non-English language translation of this Sale Agreement is done for local requirements and in the event of a dispute between the English and any non-English versions, the English version of this Sale Agreement shall govern.

---

## EXHIBIT A: END USER SOFTWARE LICENSE

---

### **IMPORTANT**

**PLEASE READ THE TERMS AND CONDITIONS OF THIS SOFTWARE LICENSE AGREEMENT CAREFULLY BEFORE AGREEING TO INSTALL THE SOFTWARE. THIS IS A LEGAL AGREEMENT BETWEEN GIATEC AND THE END USER (“CUSTOMER”).**

**GIATEC IS WILLING TO LICENSE THE SOFTWARE WITH WHICH THIS AGREEMENT IS PROVIDED (“THE SOFTWARE”) TO THE CUSTOMER UTILIZING THE SOFTWARE ONLY ON THE CONDITION THAT THE CUSTOMER, ACTING THROUGH YOU, THE CUSTOMER’S AUTHORIZED AGENT, ACCEPT ALL OF THE TERMS OF THIS AGREEMENT.**

**BY CLICKING ON THE “I ACCEPT THE TERMS IN THE LICENSE AGREEMENT” RADIO BUTTON BELOW, YOU, ON BEHALF OF CUSTOMER, AGREE TO, AND ARE LEGALLY BOUND BY, THE TERMS AND CONDITIONS OF THIS AGREEMENT.**

**IF YOU DO NOT AGREE WITH, AND DO NOT WISH TO BE LEGALLY BOUND BY, THE TERMS AND CONDITIONS OF THIS AGREEMENT DO NOT CLICK ON THE "I ACCEPT THE TERMS IN THE LICENSE AGREEMENT" RADIO BUTTON AND THE INSTALLATION PROCESS WILL STOP.**

### **Copyright/Proprietary Protection**

The Giatec Software (the "Software") and the Documentation (all of the online help files and manuals, and all of the printed material included with this Software) are owned by Giatec and are protected by Canadian, United States and international copyright laws and international treaty provisions. You must treat this Software like any other copyrighted material, with the exceptions outlined in the following License Grant. Any violation of this agreement will automatically terminate your right to use this Software, and you must immediately return it to Giatec.

Giatec trademarks contained in the Software are trademarks or registered trademarks of Giatec in Canada, the United States and/or other countries. Third party trademarks, trade names, product names and logos may be the trademarks or registered trademarks of their respective owners. You may not remove or alter any trademark, trade names, product names, logo or other proprietary notices, legends, symbols or labels in the Software.

### **License Grant**

Giatic grants you a nonexclusive license to use this Software on a single (dedicated) computer. You may copy this Software onto the hard disk of this computer, and make one copy for archival purposes. You may not make copies of the Software for any purpose other than what is stated above. You may not copy the Documentation for any reason. You may not reverse engineer, disassemble, decompile or attempt to discover the source code of the Software. You may not modify the Software or create derivative products using this Software. You may not sublicense, rent or lease any portion of the Software. You may transfer your rights under this agreement on a Permanent basis to another person or entity provided that you transfer this License Agreement, all original and updated Software and Documentation, and that you not retain any copies of the Software or Documentation. You must notify Giatic in writing of your transfer, and the recipient must also agree to the terms of this License Agreement. If you want to share the Software on a network, please contact Giatic to request a Network License Agreement.

### **Limited Warranty**

Giatic warrants the physical compact disk(s) on which the Software is distributed to be free from defects in materials and workmanship and that the Software will function in substantial accordance to the specifications for a period of one (1) year from the date of shipment of the Software to Customer. General and specific limitations on this warranty are described in Giatic's "Warranty" statement, and are incorporated by reference. THE WARRANTIES DESCRIBED HEREIN AND/OR ACCOMPANYING PRODUCTS ARE IN LIEU OF ALL OTHER WARRANTIES OR CONDITIONS AND, SAVE AS OTHERWISE PROVIDED HEREIN, GIATEC MAKES AND THERE ARE NO OTHER WARRANTIES OR CONDITIONS OR REPRESENTATIONS OF ANY KIND WHETHER EXPRESSED OR IMPLIED, AND GIATEC EXPRESSLY DISCLAIMS THE IMPLIED WARRANTIES OR CONDITIONS OF MERCHANTABILITY, FITNESS FOR A PARTICULAR PURPOSE, AND THOSE ARISING BY STATUTE OR OTHERWISE IN LAW OR FROM A COURSE OF DEALING OR USAGE OF TRADE. GIATEC DOES NOT REPRESENT OR WARRANT THAT THE PRODUCTS WILL MEET ANY OR ALL OF ANY ORGANIZATION'S PARTICULAR REQUIREMENTS, THAT THE OPERATION OF THE PRODUCTS WILL BE ERROR FREE OR UNINTERRUPTED. Any written or oral information or advice given by Giatic distributors, agents or employees will in no way increase the scope of this warranty.

### **No Liability for Consequential or Incidental Damages and Limitation of Liability**

IN NO EVENT SHALL GIATEC, ITS SUPPLIERS OR DISTRIBUTORS BE LIABLE FOR ANY CONSEQUENTIAL OR INCIDENTAL DAMAGES WHATSOEVER (INCLUDING, WITHOUT LIMITATION, DAMAGES FOR LOSS OF PROFITS, BUSINESS INTERRUPTION, LOSS OF INFORMATION, OTHER PECUNIARY LOSS OR ATTORNEY FEES) ARISING OUT OF THE USE OF OR THE INABILITY TO USE THIS SOFTWARE, EVEN IF GIATEC OR ITS SUPPLIERS OR DISTRIBUTORS HAVE BEEN ADVISED OF THE POSSIBILITY OF SUCH DAMAGES. BECAUSE SOME JURISDICTIONS DO NOT ALLOW THE EXCLUSION OR LIMITATION OF LIABILITY

FOR CONSEQUENTIAL OR INCIDENTAL DAMAGES, THE ABOVE LIMITATION MAY NOT APPLY TO YOU. FURTHER, TO THE EXTENT PERMITTED BY LAW, IN NO EVENT SHALL GIATEC'S LIABILITY AS TO ANY AND ALL DAMAGES ARISING OUT OF THIS AGREEMENT OR THE USE OF SOFTWARE EXCEED THE AMOUNT PAID BY YOU FOR THE RIGHT TO USE THIS SOFTWARE.

### **Export Controls**

This Software is subject to the export control laws of Canada, the United States and applicable export and import control laws of other countries. You agree to comply with and use the Software in a manner consistent with such applicable laws. All rights to use the Software are granted on condition that such rights are forfeited if you fail to comply with this Agreement.

### **General Provisions**

This Agreement constitutes the entire agreement between you and Giatec and supersedes any prior agreement concerning the Software. Giatec is not bound by any provision of any purchase order or any other type of correspondence (written or verbal). Should any court of competent jurisdiction find any provision in this Agreement to be illegal, unenforceable, invalid, or to be overreaching, in whole or in part and for any reason, such illegal, unenforceable, invalid or overreaching provisions or part thereof shall be stricken from this Agreement, and such provision shall not affect the legality, enforceability, or validity of the remainder of this Agreement. This Agreement is governed by the laws of the Province of Ontario and any disputes or claims arising hereunder shall be under the exclusive jurisdiction of the courts situated in the City of Ottawa, Province of Ontario.









Giatec Scientific Inc.  
301 Moodie Drive, Suite 302,  
Ottawa, ON, K2H 9C4, CANADA

Phone: +1 (613) 240-7451  
Fax: +1 (613) 280-1544  
support@giatecscientific.com  
[www.giatec.ca](http://www.giatec.ca)